

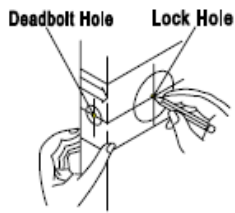

# Bulldog Grade 2 Deadbolt Installation Instructions

## 1. MARK DOOR



Start approximately 36"(915mm) from floor. Fold and apply template to edge of door bevel and mark center point on door edge for latch as indicated on template. Mark center point on door face for lock body per as guide on template.

**NOTE:** Lock Hole distance to door edge must be same as lock backset.

## 2. BORE TWO HOLES

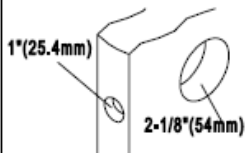

Set center hole according to length of deadbolt and backset of template.

**A.** Bore a dia. 2-1/8"(54mm) hole in center of door face for lock body. (Recommends to bore hole from both sides to avoid splintering.)

**B.** Bore a dia. 1"(25mm) hole in center of door edge for latch.

## 3. INSTALL DEADBOLT



**A.** Insert deadbolt into latch hole, keep it parallel to face of door. Mark outline of faceplate and remove deadbolt. If 1-1/8"(28.4mm) width of faceplate needed, mark outline of faceplate washer.

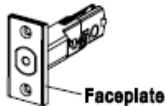

Faceplate

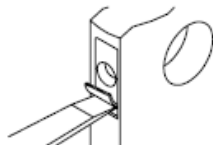

**B.** Chisel 11/64"(4.3mm) deep or until dead-bolt faceplate is flush with door edge. If 1-1/8"(28.4mm) width of faceplate needed, depth should be deeper to 3/16"(4.8mm).

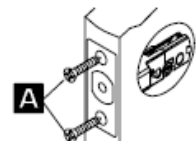

A

**C.** Insert deadbolt and fasten wood screw A.

## 4. INSTALL STRIKE

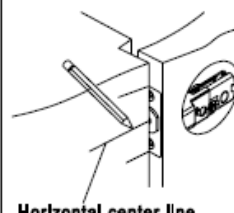

Horizontal center line

**A.** Close door until deadbolt touch door jamb. Along faceplate to mark horizontal center line.

Measure one half of door thickness from one half of door jamb and mark vertical center line.

Extend horizontal center line and vertical center line to mark drill center point for strike.

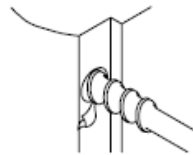

**B.** Bore a dia. 1"(25.4mm) hole and depth 1-1/16"(27mm) in door jamb at center point for latchbolt

**NOTE:** To assure proper lockset function, hole in jamb must be drilled at least depth 1"(25.4mm).

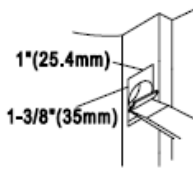

1"(25.4mm)

1-3/8"(35mm)

**C.** Chisel 1"(25.4mm) wide, 1-3/8"(35mm) high, 3/8"(10mm) deep along inside strike outline in door jamb.

**NOTE:** Center point of inside strike hole must be as same as center point of dia. 1"(25.4mm) hole



Inside strike

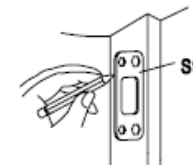

Strike

**D.** Chisel 3/16"(4.5mm) deep along strike outline in door jamb until strike flush with door jamb.

**NOTE:** Center point of strike outline must be as same as the center point of 1"(25.4mm) dia. hole

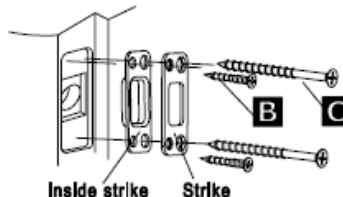

Inside strike Strike

**E.** Insert strikes into hole, tighten firmly with screws B and C.



# Bulldog Grade 2 Deadbolt Installation Instructions

## 5. INSTALL SINGLE CYLINDER

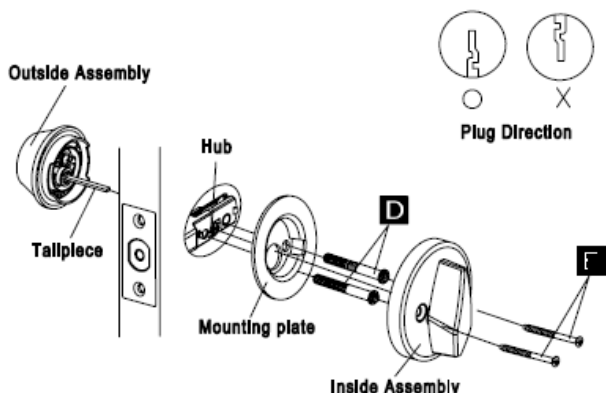

A. Install "Exterior Assembly" onto door by sliding flat tailpiece horizontally through hub on deadbolt.

NOTE: Key hole must be downward (shown in fig).

B. Install "Mounting Plate" onto door, flush with screw holes on Outside Assembly, inside mounting plate, and latch, tighten with screw D.

C. Install "Inside Assembly" onto door, flush with screw holes on Inside Assembly and screw D, tighten screw E.

## 6. INSTALL DOUBLE CYLINDER

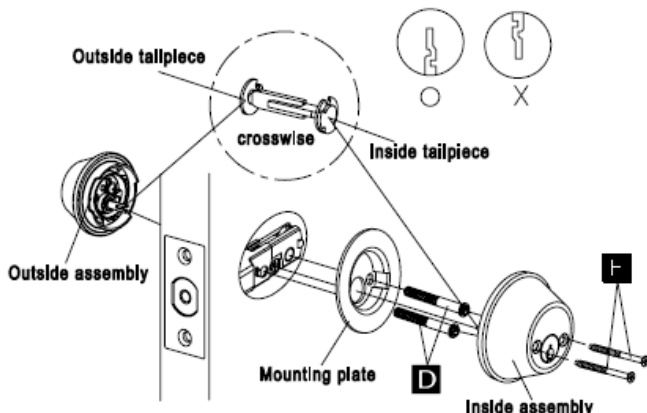

A. Install "Outside Assembly" onto door by sliding flat tailpiece vertically through hub on deadbolt.

NOTE: Key hole must be downward (shown in fig).

B. Install "Mounting Plate" onto door, flush with screw holes on Outside Assembly, inside mounting plate, and deadbolt, tighten with screw D.

C. Install "Inside Assembly" onto door by sliding flat tailpiece horizontally through hub on deadbolt. Cross outside tailpiece and inside tailpiece (shown in fig).

D. Install "Inside Assembly" onto door flush with screw holes on Inside Assembly and screw D, tighten screw E.

NOTE 1: 5 kinds of screws in pack, 2 screws each kind, total 10 pieces. Install per as mark hereunder.



NOTE 2: Be careful on adjusting backset from 60mm to 70mm.

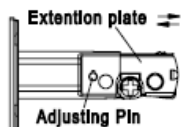

Backset 2-3/8" (60mm)

NOTE: Adjusting Pin must return to original position after moving it.

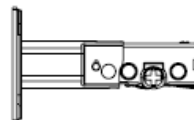

Backset 2-3/8" (70mm)

a. Move backset from 2-3/8" (60mm) to 2-3/4" (70mm): Pull Adjusting Pin up against and move Extention plate all the way to the right and then release it.

b. Move backset from 2-3/4" (70mm) to 2-3/8" (60mm): Pull Adjusting Pin up and move Extention plate all the way to the left and then release it.